

Contents

Safety Equipment	SY-2
SciMatco Safety Storage Cabinets	SY-4
Lab Safety Equipment and Accessories	SY-5
Metal Flammable Storage	SY-6
Metal Acid Storage	SY-8
Wood Flammable Storage Base Cabinets	SY-9
Mobile Index	SY-10

Safety Equipment

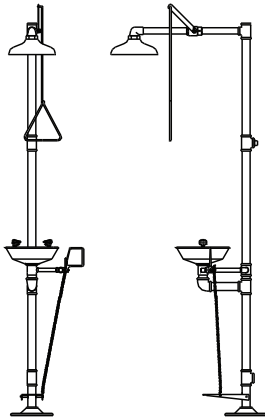

CAT. NO **SA300** (Hand and Foot Control)
SA301 (Hand Control Only)

DESCRIPTION **Shower and Eye Wash**

- Safety station with stay-open shower valve and eye wash with stainless steel bowl and stay-open ball valve

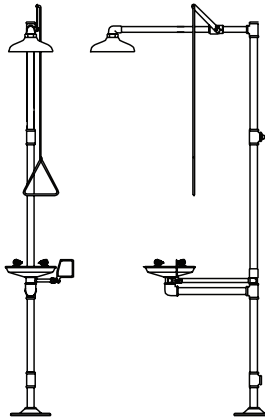

SA310

Wheelchair Accessible Shower and Eye Wash

- Barrier-free safety station with stay-open shower valve and eye/face wash with stainless steel bowl and stay-open ball valve

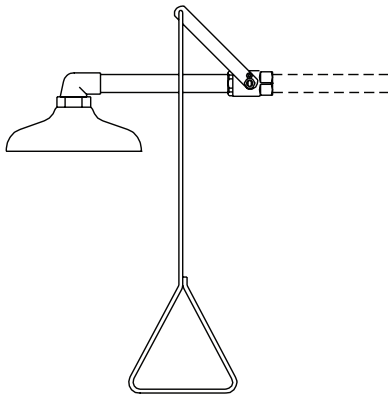

CAT. NO **SA320** (Shower Standard)
SA321 (Shower Barrier Free ADA)

DESCRIPTION **Wall Mounted Safety Shower**

- Horizontally mounter emergency shower with stay-open ball valve and pull rod

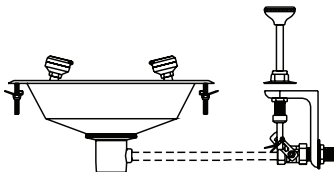
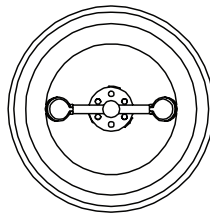

SA330

Deck Mounted Eyewash with Pull Down Knob

- Deck mounted eye wash with two gentle spray plus spray heads, recessed stainless steel bowl and push-down activated stay-open ball valve

Safety Equipment (cont'd)

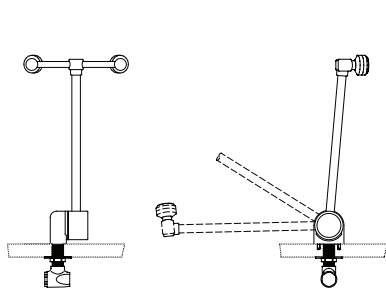
CAT. NO SA340 (Eyewash with Auto Flow)

DESCRIPTION
Eyewash

- Deck mounted eye wash with two gentle spray heads. Each head has a “flip top” dust cover, internal flow control and filter to remove impurities from the water flow. 90 degree swing down feature.

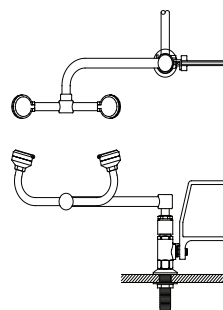

CAT. NO SA341 (Eyewash with Flag Handle)

Eyewash

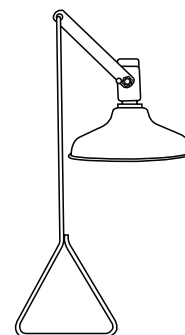
- Deck mounted eye wash with two gentle spray stay-open valves and 90 degree swivel feature (right hand mounting)

CAT. NO SA370
Vertically Mounted Emergency Shower

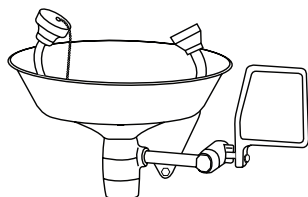
- Comes with ABS plastic shower head with stay-open shower valve and stainless steel pull rod

CAT. NO SA380
DESCRIPTION
Wall Mounted Eyewash

- Comes with 2 spray heads, stainless steel bowl, epoxy coated cast aluminum flag handle and stay-open ball valve

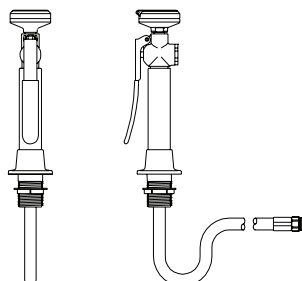
CAT. NO SA350
Drench Hose

- Deck mounted

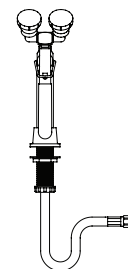
CAT. NO SA360
Eyewash / Drench Hose

- Deck mounted

SciMatco Safety Storage Cabinets

CAT. NO **LSSC8051**

- DESCRIPTION** **Wood Acid Cabinet**
- Painted Safety Blue, fully lined with Polypropylene
 - Acid Cabinets for safer chemical storage are constructed entirely of wood, which eliminates corrosion and guarantees years of safe acid storage.
 - Optional polypropylene nitric acid compartment is also available.
 - Dimensions: 31" w x 20" d x 36½" h

CAT. NO **LSSC8071**

- DESCRIPTION** **Nitric Acid Compartment for Acid Cabinet**
- For safer chemical storage is made to accommodate nitric acid and isolate it within cabinet.
 - Holds five 2.5-liter bottles
 - Fits into the top half of either acid cabinet.

CAT. NO **LSSC7133**

- DESCRIPTION** **Wood Flammable Cabinet**
- 54 Gallon Flammable Cabinet, 54 Gallon Capacity
 - Floor Flammables Cabinets for safer chemical storage include 2 adjustable shelves
 - Meets NFPA and OSHA standards.
 - Wooden construction and UL listed.
 - Dimensions: 43" w x 18" d x 44-3/4" h

CAT. NO **LSSC1460**

- DESCRIPTION** **Stak-a-Cab™ Acid**
- Stak-a-Cab™ Cabinets for safer chemical storage are constructed entirely of wood
 - Can be stacked three high with optional floor stand.
 - A safe solution for stockrooms and labs with space restrictions.
 - For mounted applications, floor stand must be specified.
 - Dimensions: 47" w x 18" d x 18" h

CAT. NO **LSSC1863**

- DESCRIPTION** **Stak-a-Cab™ Flammables, with self-closing doors**
- Stak-a-Cab™ Cabinets for safer chemical storage are constructed entirely of wood
 - Can be stacked three high with optional floor stand.
 - A safe solution for stockrooms and labs with space restrictions.
 - For mounted applications, floor stand must be specified.
 - Dimensions: 47" w x 18" d x 18" h

CAT. NO **LSSC2063**

- DESCRIPTION** **Stak-a-Cab™ Combination Acid/Flammable Cabinet, with self-closing door on flammable side**
- Stak-a-Cab™ Cabinets for safer chemical storage are constructed entirely of wood
 - Can be stacked three high with optional floor stand.
 - A safe solution for stockrooms and labs with space restrictions.
 - For mounted applications, floor stand must be specified.
 - Dimensions: 47" w x 18" d x 18" h

CAT. NO **LSSC8023**

- DESCRIPTION** **Bench Top Flammable Cabinet, with self-closing door**
- Benchtop Flammables Cabinets for safer chemical storage
 - Ideal for small schools or science departments, such as biology, where small quantities of flammables are stored
 - Dimensions: 16¾" w x 15¾" d x 21¼" h

CAT. NO **LSSC8063**

- DESCRIPTION** **Bench Top, Acid Cabinet**
- Bench Top Acid Cabinet for safer chemical storage
 - Ideal for biology storerooms, small schools with limited acid quantities and storage of corrosives you want to separate from principal acid storage
 - Dimensions: 16¾" w x 15¾" d x 21¼" h

CAT. NO **LSSC6080**

- DESCRIPTION** **Bench Top, Poison Cabinet**
- Bench Top Poison Cabinet is constructed of 1-inch exterior grade plywood and is finished with chemical resistance paint
 - Includes one fixed-position shelf and heavy-duty lock
 - Dimensions: 16¾" w x 15¾" d x 21¼" h

Lab Safety Equipment and Accessories

CAT. NO LSSE1034

DESCRIPTION
Fire Extinguisher

- Lab Safety Dry Chemical Fire Extinguishers are your best choice for the science laboratory
- Treats most fire types and easy-to-operate

CAT. NO LSSE1082

First Aid Kit – 25 People

- Designed to meet OSHA and ANSI first aid requirements.
- Durable, steel box has a built-in handle and is wall mountable.

CAT. NO LSSE1083

First Aid Kit – 50 People

- Designed to meet OSHA and ANSI first aid requirements.
- Durable, steel box has a built-in handle and is wall mountable.

CAT. NO LSSE3006

DESCRIPTION
Fire Blanket Storage Cabinet

- Blanket and Case
- Features a woolen blanket for smothering fires and for containing and controlling chemical spills
- Includes wall mounted metal case

CAT. NO LSSE3008

Fire Blanket Storage Cabinet

- Wall mounted metal case only

CAT. NO LSSE3007

Fire Blanket

- Blanket only
- Woolen blanket for smothering fires and for containing and controlling chemical spills

CAT. NO LSAP6448

DESCRIPTION
Spill Control Kit

- Everything you need to handle most laboratory spill emergencies in one convenient location

CAT. NO LSSE1093

Goggle Sanitizers

- Designed to effectively clean goggles in between uses
- UV-C Germicidal bulb emits very short ultraviolet wavelengths of light
- Studies have shown that UV-C light damages the DNA of bacteria, viruses, and other pathogens to prevent replication
- Stores multiple pairs of goggles or safety glasses

Metal Flammable Storage

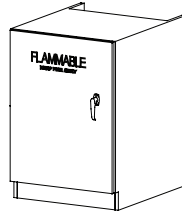
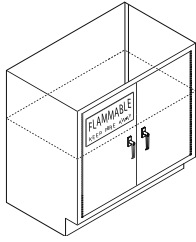
CAT. NO **SC310**
DESCRIPTION **UL Listed Metal Flammable Storage Cabinet (Manual Closing)**

- Double doors

HEIGHT 29* (Sitting) | 35 (Standing)

DEPTH 18 | 22

WIDTH 30 | 36 | 42 | 48 | 52

* Note: Spacer apron required for ADA installation.

SC311 (Hinged L) **SC312** (Hinged R)

DESCRIPTION **UL Listed Metal Flammable Storage Cabinet (Manual Closing)**

- Single door

HEIGHT 29 (Sitting) | 35 (Standing)

DEPTH 18 | 22

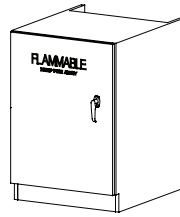
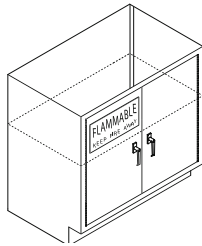
WIDTH 24

CAT. NO **SC330**
DESCRIPTION **Non-UL Flammable Storage Base Cabinet (Self Closing/Latching)**
HEIGHT 29 | 35

DEPTH 18

WIDTH 30 | 36 | 42 | 48 | 52 | 58

SC331 (Hinged L) **SC332** (Hinged R)

DESCRIPTION **Non-UL Flammable Storage Base Cabinet (Self Closing/Latching)**
HEIGHT 29 | 35

DEPTH 18

WIDTH 30 | 36 | 42 | 48 | 52 | 58

Metal Flammable Storage (cont'd)

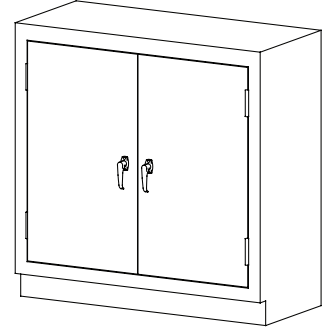
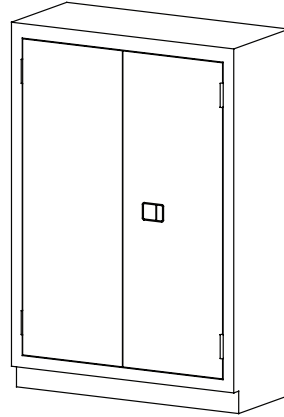
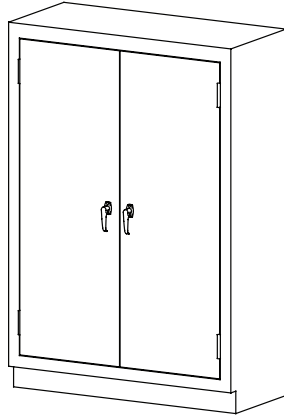
CAT. NO **SC360**
DESCRIPTION 45 Gallon Capacity Flammable Storage Tall Cabinet (Manual Close)

HEIGHT 65

DEPTH 18

WIDTH 43

SC365
DESCRIPTION 45 Gallon Capacity Flammable Storage Tall Cabinet (Self Close)

HEIGHT 65

DEPTH 18

WIDTH 43

SC370
DESCRIPTION 30 Gallon Capacity Flammable Storage Tall Cabinet (Manual Close)

HEIGHT 45

DEPTH 18

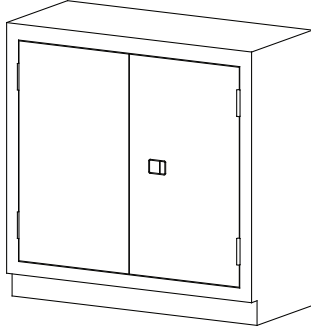
WIDTH 43

CAT. NO **SC375**
DESCRIPTION 30 Gallon Capacity Flammable Storage Tall Cabinet (Self Close)

HEIGHT 45

DEPTH 18

WIDTH 43

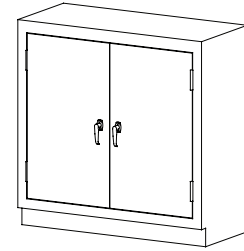
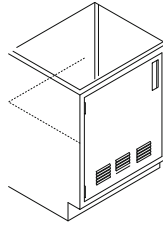
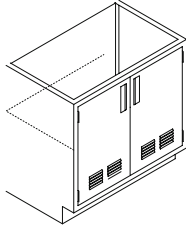
Metal Acid Storage



CAT. NO	SC230
DESCRIPTION	Acid Storage Base • One door, no panel
HEIGHT	29* (Sitting) 35 (Standing)
DEPTH	18 22
WIDTH	30 36 42 48 52 58

CAT. NO	SC231 (Hinged L) SC232 (Hinged R)
DESCRIPTION	Acid Storage • One door, no panel • Drawing is for concept only. Single door cabinet will be supplied
HEIGHT	29 (Sitting) 35 (Standing)
DEPTH	18 22
WIDTH	24

CAT. NO	SC380
DESCRIPTION	30 Gallon Capacity Acid Storage Tall Cabinet (Manual Close)
HEIGHT	45
DEPTH	18
WIDTH	43

* Note: Spacer apron required for ADA installation.

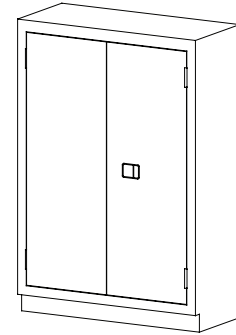
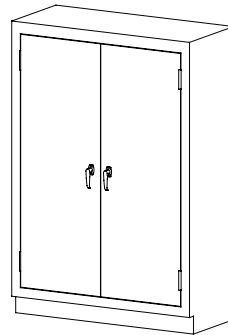
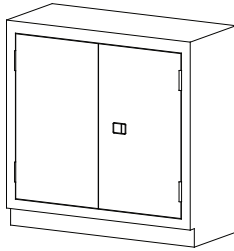

CAT. NO	SC385
DESCRIPTION	30 Gallon Capacity Acid Storage Tall Cabinet (Self Close)
HEIGHT	45
DEPTH	18
WIDTH	43

CAT. NO	SC390
DESCRIPTION	45 Gallon Capacity Acid Storage Tall Cabinet (Manual Close)
HEIGHT	65
DEPTH	18
WIDTH	43

CAT. NO	SC395
DESCRIPTION	45 Gallon Capacity Acid Storage Tall Cabinet (Self Close)
HEIGHT	65
DEPTH	18
WIDTH	43

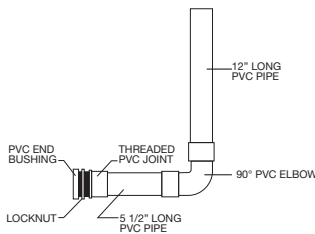

CAT. NO	SCV00
DESCRIPTION	Vent Kit • For use in under-counter acid cabinets only

Wood Flammable Storage Base Cabinets

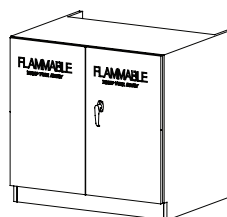
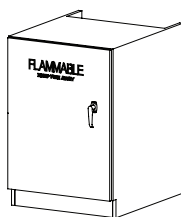

CAT. NO **SC311** (Hinged L) **SC312** (Hinged R)

DESCRIPTION **Wood Flammable Storage Cabinet (Manual Closing)**

- Doors are made to match the wood veneer species of your project.
- Not UL Listed

HEIGHT 28 | 35

DEPTH 18 | 22

WIDTH 24

SC310

Wood Flammable Storage Cabinet (Manual Closing)

- Double doors are made to match the wood veneer species of your project.
- Not UL Listed

HEIGHT 28 | 35

DEPTH 18 | 22

WIDTH 30 | 36

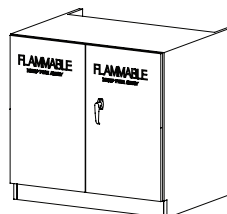
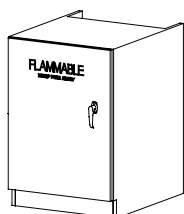

CAT. NO **SC311-SC** (Hinged L) **SC312-SC** (Hinged R)

DESCRIPTION **UL Listed Wood Flammable Storage Cabinet (Self Closing/Latching)**

- Doors are made to match the wood veneer species of your project.

HEIGHT 28 | 35

DEPTH 18 | 22

WIDTH 24

SC310-SC

UL Listed Wood Flammable Storage Cabinet (Self Closing/Latching)

- Double doors are made to match the wood veneer species of your project.

HEIGHT 28 | 35

DEPTH 18 | 22

WIDTH 30 | 36

Safety Index

General Information	SY-2	Metal Flammable Storage	SY-6
Safety Equipment	SY-2	SC310	UL Listed Metal Flammable Storage Cabinet (Manual Close) ... SY-6
SA300 Shower and Eye Wash	SY-2	SC311	UL Listed Metal Flammable Storage Cabinet (Manual Close) ... SY-6
SA301 Shower and Eye Wash	SY-2	SC312	Non-UL Flammable Storage Base Cabinet (Self Close/Latch)... SY-6
SA310 Wheelchair Accessible Shower and Eye Wash	SY-2	SC330	Non-UL Flammable Storage Base Cabinet (Self Close/Latch)... SY-6
SA320 Wall Mounted Safety Shower	SY-2	SC331	UL Listed Metal Flammable Storage Cabinet (Manual Close) ... SY-6
SA321 Wall Mounted Safety Shower	SY-2	SC332	UL Listed Metal Flammable Storage Cabinet (Manual Close) ... SY-6
SA330 Deck Mounted Eyewash with Pull Down Knob	SY-2	SC360	45 Gal. Cap. Flammable Storage Tall Cabinet (Manual Close).. SY-7
SA340 Eyewash	SY-3	SC365	45 Gal. Cap. Flammable Storage Tall Cabinet (Self Close) SY-7
SA341 Eyewash	SY-3	SC370	30 Gal. Cap. Flammable Storage Tall Cabinet (Manual Close).. SY-7
SA370 Vertically Mounted Emergency Shower	SY-3	SC375	30 Gal. Cap. Flammable Storage Tall Cabinet (Self Close) SY-7
SA380 Wall Mounted Eyewash	SY-3	Metal Acid Storage	SY-8
SA350 Drench Hose	SY-3	SC230	Acid Storage Base..... SY-8
SA360 Eyewash / Drench Hose	SY-3	SC231	Acid Storage
SciMatco Safety Storage Cabinets	SY-4	SC232	30 Gal. Cap. Acid Storage Tall Cabinet (Manual Close)..... SY-8
LSSC8051 Wood Acid Cabinet	SY-4	SC380	30 Gal. Cap. Acid Storage Tall Cabinet (Self Close)
LSSC8071 Nitric Acid Compartment for Acid Cabinet	SY-4	SC385	45 Gal. Cap. Acid Storage Tall Cabinet (Manual Close)..... SY-8
LSSC7133 Wood Flammable Cabinet	SY-4	SC390	45 Gal. Cap. Acid Storage Tall Cabinet (Self Close)
LSSC1460 Stak-a-Cab™ Acid	SY-4	SC395	Vent Kit
LSSC1863 Stak-a-Cab™ Flammables, with self-closing doors	SY-4	SCV00	Acid Storage Base..... SY-8
LSSC2063 Stak-a-Cab™ Combination Acid/Flammable Cabinet, with self-closing door on flammable side.....	SY-4	Wood Flammable Storage Base Cabinets	SY-9
LSSC8023 Bench Top Flammable Cabinet, with self-closing door.....	SY-4	SC311	Wood Flammable Storage Cabinet (Manual Close)..... SY-9
LSSC8063 Bench Top, Acid Cabinet	SY-4	SC312	Wood Flammable Storage Cabinet (Manual Close)..... SY-9
LSSC6080 Bench Top, Poison Cabinet	SY-4	SC310	Wood Flammable Storage Cabinet (Self Close/Latch)
Lab Safety Equipment and Accessories	SY-5	SC311-SC	UL Listed Wood Flammable Storage Cabinet (Self Close/Latch). SY-9
LSSE1034 Fire Extinguisher	SY-5	SC312-SC	UL Listed Wood Flammable Storage Cabinet (Manual Close)..... SY-9
LSSE1082 First Aid Kit – 25 People	SY-5	SC310-SC	UL Listed Wood Flammable Storage Cabinet (Manual Close)..... SY-9
LSSE1083 First Aid Kit – 50 People	SY-5	Safety Index	SY-10
LSSE3006 Fire Blanket Storage Cabinet	SY-5		
LSSE3008 Fire Blanket Storage Cabinet	SY-5		
LSSE3007 Fire Blanket	SY-5		
LSAP6448 Spill Control Kit.....	SY-5		
LSSE1093 Goggle Sanitizers	SY-5		