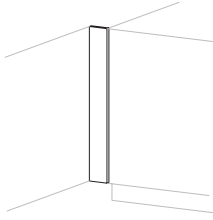

Contents

Base Fillers	WF-2
Finished Backs	WF-4
Finished Tops	WF-5
Wall Fillers	WF-6
Tall Fillers	WF-7
Knee Spaces Valances, Aprons and Book Boxes	WF-9
Fillers and Knee Spaces Index	WF-10

Base Fillers

CAT. NO **R1200**
DESCRIPTION **Base Scribing Filler**
 • Toe kick not included.
 • Small panels will be consolidated to 24-inch wide panels for field cutting

HEIGHT 13 | 15 | 17 | 23 | 26 | 29 | 32.75 | 35

WIDTH 2-48

CAT. NO **R1230**
DESCRIPTION **Solid 1-Inch Wood Base Filler**
HEIGHT 13 | 15 | 17 | 23 | 26 | 29 | 32.75 | 35

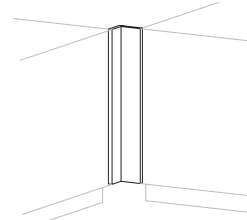
WIDTH 1

CAT. NO **R1250**
DESCRIPTION **Base Corner Filler**
 • Toe kick not included.

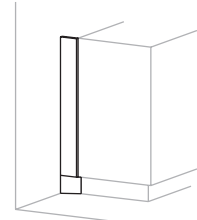
HEIGHT 13 | 15 | 17 | 23 | 26 | 29 | 32.75 | 35

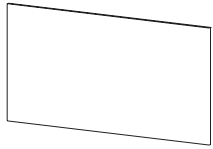
WIDTH 3-12

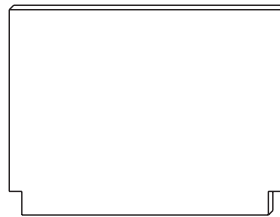
CAT. NO **R1210**
DESCRIPTION **Base End Filler**
HEIGHT 13 | 15 | 17 | 23 | 26 | 29 | 32.75 | 35

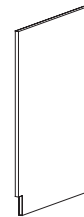
WIDTH 2-24

CAT. NO **F4101**
DESCRIPTION **Base Cabinet Finished Back Panel**
HEIGHT 13 | 15 | 17 | 23 | 26 | 29 | 32.75 | 35

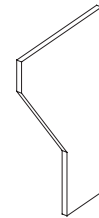
WIDTH 15 | 18 | 21 | 24 | 30 | 36 | 42 | 48

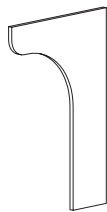
CAT. NO **R2180**
DESCRIPTION **Island End Gable Panel**
HEIGHT 29 | 32.75 | 35

WIDTH 46 | 52 | 58

CAT. NO **R2100**
DESCRIPTION **End Gable Panel**
HEIGHT 29 | 32.75 | 35

WIDTH 15 | 22 | 29 | 35

CAT. NO **R2150**
DESCRIPTION **End Gable Panel**
HEIGHT 29 | 32.75 | 35

WIDTH 15 | 22 | 29 | 35

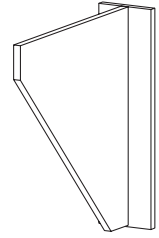
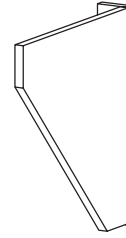
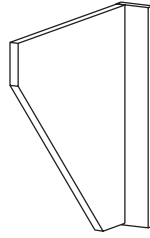
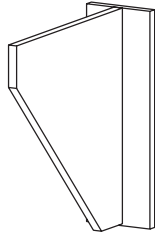
CAT. NO **R2070**
DESCRIPTION **End Gable Panel With Scoop Design**
HEIGHT 29 | 32.75 | 35

WIDTH 15 | 22 | 29 | 35

Base Fillers (cont'd)



CAT. NO	X0100
DESCRIPTION	Center Wall Mount Support Bracket
HEIGHT	18
DEPTH	18
WIDTH	06

CAT. NO	X0110
DESCRIPTION	Left End Wall Mount Support Bracket
HEIGHT	18
DEPTH	18
WIDTH	03

CAT. NO	X0120
DESCRIPTION	Right End Wall Mount Support Bracket
HEIGHT	18
DEPTH	18
WIDTH	03

CAT. NO	X0400
DESCRIPTION	Center Wall Mount Support Bracket
HEIGHT	24
DEPTH	24
WIDTH	06

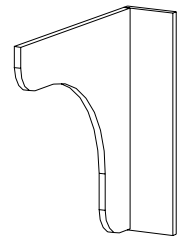
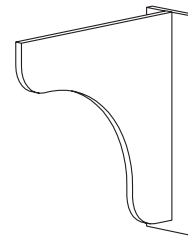
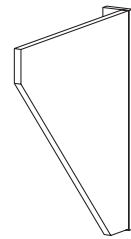
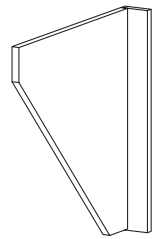

CAT. NO	X0410
DESCRIPTION	Left End Wall Mount Support Bracket
HEIGHT	24
DEPTH	24
WIDTH	03

CAT. NO	X0420
DESCRIPTION	Right End Wall Mount Support Bracket
HEIGHT	24
DEPTH	24
WIDTH	03

CAT. NO	X0700
DESCRIPTION	Wall Mount Support Bracket • .020 edge only
HEIGHT	21
DEPTH	21
WIDTH	06

CAT. NO	X0710
DESCRIPTION	Left End Wall Mount Support Bracket • .020 edge only
HEIGHT	21
DEPTH	21
WIDTH	03

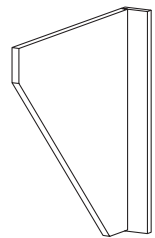

CAT. NO	X0720
DESCRIPTION	Right End Wall Mount Support Bracket • .020 edge only
HEIGHT	21
DEPTH	21
WIDTH	03

Finished Backs

Horizontal Grained Finished Backs

F4000 (96mm from bottom) **F4001** (to floor)

Individual Unit
H 12 to 48

D 01

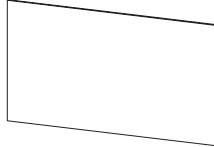
W 12 to 95

F4010 (96mm from bottom) **F4011** (to floor)

Starter Unit (Mechanical Fastener Right Edge)
H 12 to 48

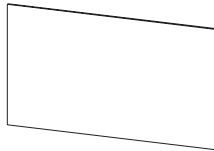
D 01

W 12 to 95

F4020 (96mm from bottom) **F4021** (to floor)

Adder Unit (Mechanical Fastener Left & Right)
H 12 to 48

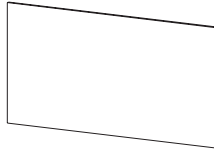
D 01

W 12 to 95

F4030 (96mm from bottom) **F4031** (to floor)

Right End Unit (Mechanical Fastener Left Edge)
H 12 to 48

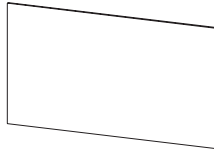
D 01

W 12 to 95

F4050 (96mm from bottom) **F4051** (to floor)

Starter Unit (Dowel Joined)
H 12 to 48

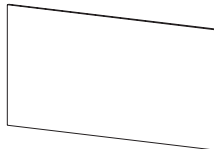
D 01

W 12 to 95

F4060 (96mm from bottom) **F4061** (to floor)

Adder Unit (Dowel Joined)
H 12 to 48

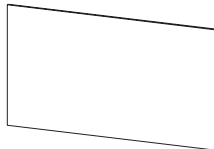
D 01

W 12 to 95

F4070 (96mm from bottom) **F4071** (to floor)

Right End Unit (Dowel Joined)
H 12 to 48

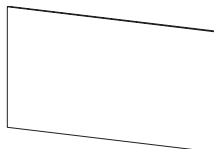
D 01

W 12 to 95

Vertical Grained Finished Backs

F4100 (96mm from bottom) **F4101** (to floor)

Individual Unit
H 12 to 95

D 01

W 12 to 48

F4110 (96mm from bottom) **F4111** (to floor)

Starter Unit (Mechanical Fastener Right Edge)
H 12 to 95

D 01

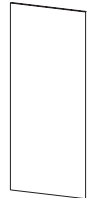
W 12 to 48

F4120 (96mm from bottom) **F4121** (to floor)

Adder Unit (Mechanical Fastener Left & Right)
H 12 to 95

D 01

W 12 to 48

F4130 (96mm from bottom) **F4131** (to floor)

Right End Unit (Mechanical Fastener Left Edge)
H 12 to 95

D 01

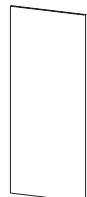
W 12 to 48

F4150 (96mm from bottom) **F4151** (to floor)

Starter Unit (Dowel Joined)
H 12 to 95

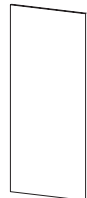
D 01

W 12 to 48

F4160 (96mm from bottom) **F4161** (to floor)

Adder Unit (Dowel Joined)
H 12 to 95

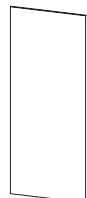
D 01

W 12 to 48

F4170 (96mm from bottom) **F4171** (to floor)

Right End Unit (Dowel Joined)
H 12 to 95

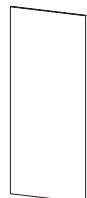
D 01

W 12 to 48

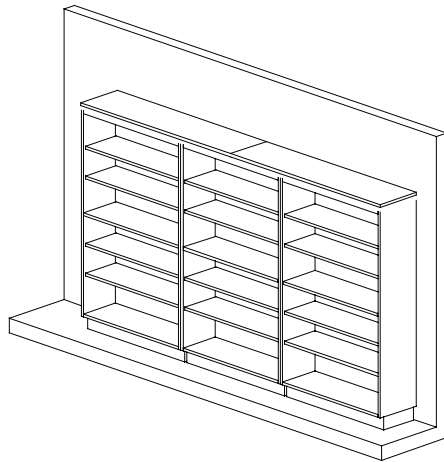
Finished Tops



F5000 For runs of casework. Left or right ends finished as needed.

Continuous Top

D 12 | 13 | 15 | 17 | 22

W Any length as needed - 12" min. to max. panel length of 95"

NOTE: If over 96" wide, parts are joined with mechanical fasteners

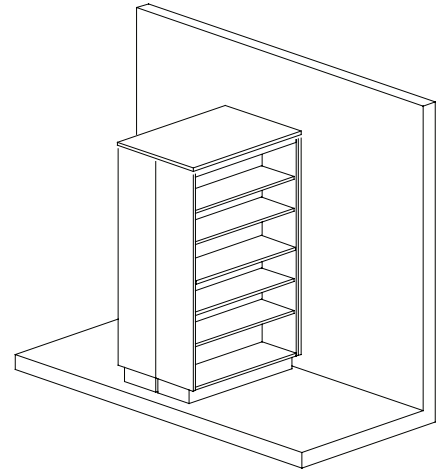

F5050 For peninsula casework. Left or right ends finished as needed.

Continuous Double-sided Top

D Any depth as needed

W Any length as needed - 12" min. to max. panel length of 95"

NOTE: If over 96" wide, parts are joined with mechanical fasteners

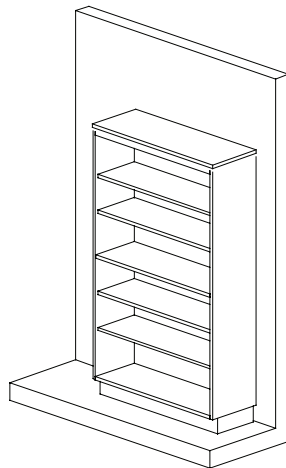

F5200 For individual casework. Left or right ends finished as needed.

Individual Top

D 12 | 13 | 15 | 17 | 22

W All standard nominal widths available
12" to 96"

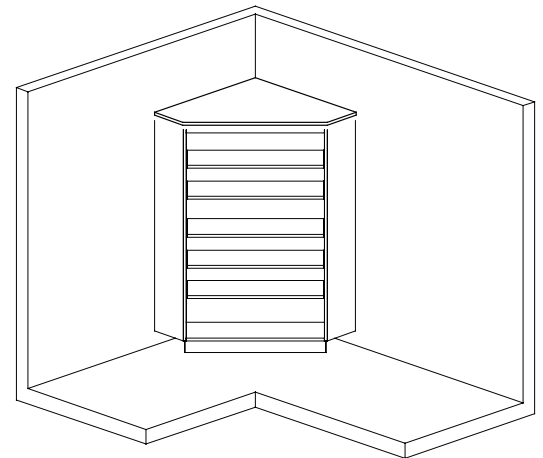

F5300 For corner mounted casework. Left or right ends finished as needed.

Corner Unit Top

D Custom - 12" min. to 48" max.

W Custom - 12" min. to 48" max.

Wall Fillers

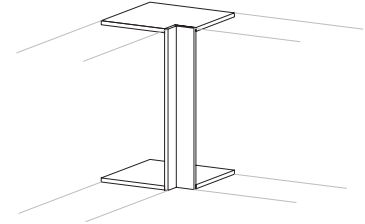
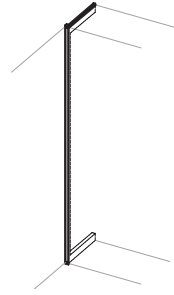
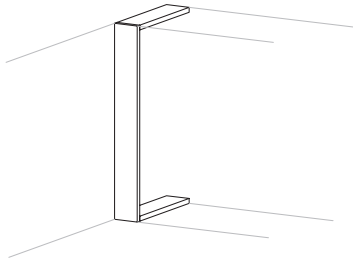
CAT. NO **R1000**
DESCRIPTION Wall Scribing Filler
 • Shipped unassembled

HEIGHT 12 | 16 | 18 | 24 | 27 | 30 | 32 | 36 |
 42 | 48

DEPTH 12 | 13 | 15 | 17

WIDTH 02-48

CAT. NO **R1030**
DESCRIPTION Solid 1-inch Wood Wall Filler
 • Shipped unassembled

HEIGHT 12 | 16 | 18 | 24 | 27 | 30 | 32 | 36 |
 42 | 48

DEPTH 12 | 13 | 15 | 17

WIDTH 1

CAT. NO **R1050**
DESCRIPTION Wall Corner Filler
 • Shipped unassembled

HEIGHT 12 | 16 | 18 | 24 | 27 | 30 | 32 | 36 |
 42 | 48

DEPTH 12 | 13 | 15 | 17

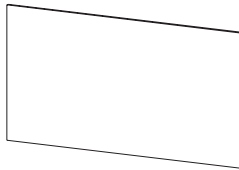
WIDTH 3-12

CAT. NO **F4090**
DESCRIPTION Wall Cabinet Finished Back And Bottom Edge

HEIGHT 12 | 16 | 18 | 24 | 27 | 30 | 32 | 36 |
 42 | 48

WIDTH 12-48

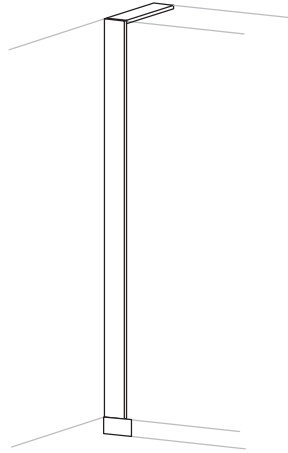
Tall Fillers

CAT. NO **R1300**
DESCRIPTION Tall Cabinet Front Filler Panel

HEIGHT 60 | 66 | 72 | 78 | 84 | 88 | 90 | 95

DEPTH 12 | 15 | 22

WIDTH 2-48

CAT. NO **R1330**
DESCRIPTION Solid 1-inch Wood Tall Filler

HEIGHT 60 | 66 | 72 | 78 | 84 | 88 | 90 | 95

DEPTH 12 | 15 | 22

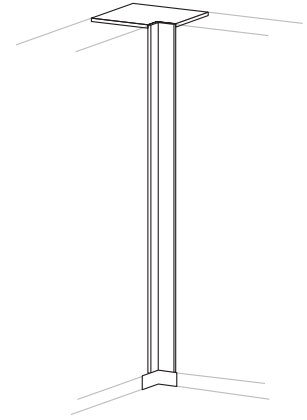
WIDTH 1

CAT. NO **R1350**
DESCRIPTION Tall Cabinet Corner Filler Panel
• Shipped unassembled

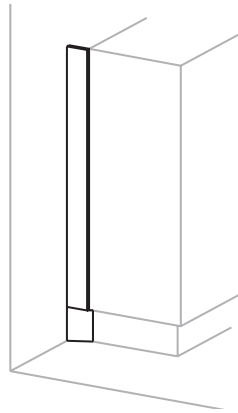
HEIGHT 60 | 66 | 72 | 78 | 84 | 88 | 90 | 95

WIDTH 3-12

CAT. NO **R1310**
DESCRIPTION Tall Cabinet End Filler Panel

HEIGHT 60 | 66 | 72 | 78 | 84 | 88 | 90 | 95

DEPTH
WIDTH 2-12

CAT. NO **R1100**
DESCRIPTION Chase Top Closure Panel

DEPTH 2-12

WIDTH 12 | 15 | 18 | 21 | 24 | 27 | 30 | 33 | 36 | 39 | 42 | 45 | 48

Tall Fillers cont'd

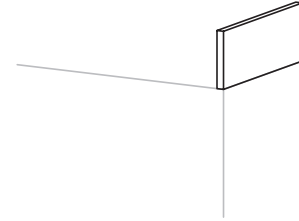
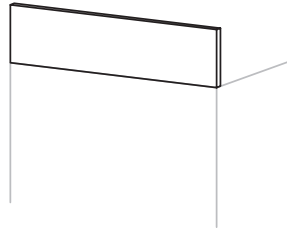

CAT. NO	F4101	R1150	R1160
DESCRIPTION	Tall Cabinet Finished Back Panel	Soffit Filler	Soffit Filler • Finished front edge
HEIGHT	60 64 66 72 78 88 90 95	3-24 (3" increments)	3-24 (3" increments)
WIDTH	12-48	12-96 (3" increments)	12 15 22

Knee Spaces Valances, Aprons and Book Boxes

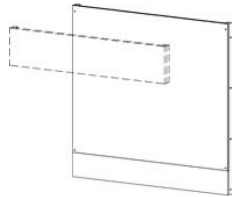
CAT. NO **R2200**
DESCRIPTION Knee Space Full Height Panel

HEIGHT 29 (Sitting) | 32 3/4 (ADA) | 35 (Standing)

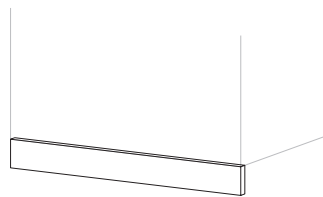
WIDTH 15 | 18 | 21 | 24 | 30 | 36 | 42 | 48

CAT. NO **R2300**
DESCRIPTION Light Valance

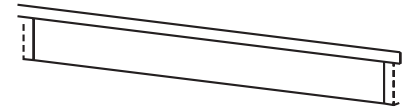
HEIGHT 4

WIDTH 15 | 18 | 21 | 24 | 30 | 36 | 42 | 48

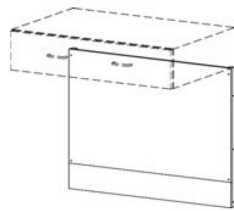
CAT. NO **R3300**
DESCRIPTION Knee Space Rail

HEIGHT 3 3/4

WIDTH 15 | 18 | 21 | 24 | 30 | 36 | 42 | 48

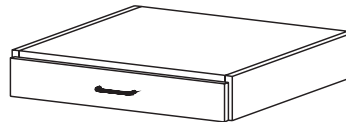
CAT. NO **R2202**
DESCRIPTION Knee Space Panel For Below Rail, Drawer Or Book Box

HEIGHT 25 1/4 (Sitting) | 29 (ADA) | 31 1/4 (Standing)

DEPTH
WIDTH 15 | 18 | 21 | 24 | 30 | 36 | 42 | 48

CAT. NO **B4740**
DESCRIPTION Single Knee Space Drawer

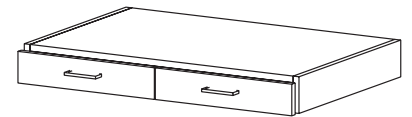
HEIGHT 3 7/8

DEPTH 16 | 23

WIDTH 18 | 21 | 24

CAT. NO **B4840**
DESCRIPTION Double Knee Space Drawer

HEIGHT 3 7/8

DEPTH 16 | 23

WIDTH 30 | 36 | 42 | 48

CAT. NO **X2000**
DESCRIPTION Book Box

HEIGHT 3 7/8

DEPTH 15 | 22

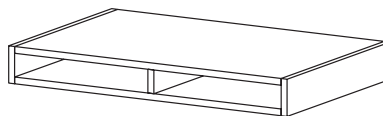
WIDTH 18 | 21 | 24

CAT. NO **X2070**
DESCRIPTION Divided Book Box

HEIGHT 3 7/8

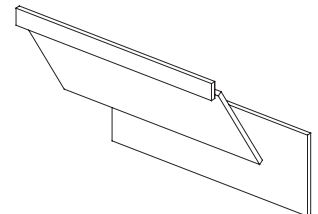
DEPTH 15 | 22

WIDTH 30 | 36 | 42 | 48

CAT. NO **D1010**
DESCRIPTION Knee Space Sink Panel

HEIGHT 32.75

DEPTH 23

WIDTH 30 | 36 | 42 | 48

Fillers and Knee Spaces Index

Base Fillers	WF-2	F4151	Starter Unit (Bisquet Joined).....	WF-4
R1200	Base Scribing Filler with Metal Kick Plate.....	F4160	Adder Unit (Dowel Joined).....	WF-4
R1230	Solid 1-Inch Wood Base Filler.....	F4161	Adder Unit (Bisquet Joined).....	WF-4
R1250	Base Corner Filler With Metal Kick Plate.....	F4170	Right End Unit (Dowel Joined).....	WF-4
R1210	Base End Filler.....	F4171	Right End Unit (Bisquet Joined).....	WF-4
F4101	Base Cabinet Finished Back Panel.....			
R2180	Island End Gable Panel.....			
R2100	End Gable Panel.....			
R2150	End Gable Panel.....			
R2070	End Gable Panel With Scoop Design.....			
X0100	Center Wall Mount Support Bracket.....			
X0110	Left End Wall Mount Support Bracket.....			
X0120	Right End Wall Mount Support Bracket.....			
X0400	Center Wall Mount Support Bracket.....			
X0410	Left End Wall Mount Support Bracket.....			
X0420	Right End Wall Mount Support Bracket.....			
X0700	Wall Mount Support Bracket.....			
X0710	Left End Wall Mount Support Bracket.....			
X0720	Right End Wall Mount Support Bracket.....			
		Finished Tops	WF-5	
		F5000	Continuous Top.....	WF-5
		F5050	Continuous Double-sided Top.....	WF-5
		F5200	Individual Top.....	WF-5
		F5300	Corner Unit Top.....	WF-5
		Wall Fillers	WF-6	
		R1000	Wall Scribing Filler.....	WF-6
		R1030	Solid 1-inch Wood Wall Filler.....	WF-6
		R1050	Wall Corner Filler.....	WF-6
		F4090	Wall Cabinet Finished Back And Bottom Edge.....	WF-6
		Tall Fillers	WF-7	
		R1300	Tall Cabinet Front Filler Panel With Metal Kick Plate.....	WF-7
		R1330	Solid 1-inch Wood Tall Filler.....	WF-7
		R1350	Tall Cabinet Corner Filler Panel With Metal Kick Plate.....	WF-7
		R1310	Tall Cabinet End Filler Panel.....	WF-7
		R1100	Chase Top Closure Panel.....	WF-7
		F4101	Tall Cabinet Finished Back Panel.....	WF-8
		R1150	Soffit Filler.....	WF-8
		R1160	Soffit Filler.....	WF-8
		Knee Spaces Valances, Aprons and Book Boxes	WF-9	
		R2200	Knee Space Full Height Panel.....	WF-9
		R2300	Light Valance.....	WF-9
		R3300	Knee Space Rail.....	WF-9
		R2202	Knee Space Panel For Below Rail, Drawer Or Book Box.....	WF-9
		B4740	Single Knee Space Drawer.....	WF-9
		B4840	Double Knee Space Drawer.....	WF-9
		X2000	Book Box.....	WF-9
		X2070	Divided Book Box.....	WF-9
		D1010	Knee Space Sink Panel.....	WF-9
Finished Backs	WF-4			
F4000	Individual Unit (No Tite-Joint).....			WF-4
F4001	Individual Unit (No Tite-Joint).....			WF-4
F4010	Starter Unit (Mechanical Fastener Right Edge).....			WF-4
F4011	Individual Unit (No Tite-Joint).....			WF-4
F4020	Adder Unit (Mechanical Fastener Left & Right).....			WF-4
F4021	Individual Unit (No Tite-Joint).....			WF-4
F4030	Right End Unit (Mechanical Fastener Left Edge).....			WF-4
F4031	Individual Unit (No Tite-Joint).....			WF-4
F4050	Starter Unit (Dowel Joined).....			WF-4
F4051	Individual Unit (No Tite-Joint).....			WF-4
F4060	Adder Unit (Dowel Joined).....			WF-4
F4061	Individual Unit (No Tite-Joint).....			WF-4
F4070	Right End Unit (Dowel Joined).....			WF-4
F4071	Individual Unit (No Tite-Joint).....			WF-4
F4100	Individual Unit (No Tite-Joint).....			WF-4
F4101	Individual Unit (No Tite-Joint).....			WF-4
F4110	Starter Unit (Mechanical Fastener Right Edge).....			WF-4
F4111	Starter Unit (Tite-Joint Right Edge).....			WF-4
F4120	Adder Unit (Mechanical Fastener Left & Right).....			WF-4
F4121	Adder Unit (Tite-Joint Left & Right).....			WF-4
F4130	Right End Unit (Mechanical Fastener Left Edge).....			WF-4
F4131	Right End Unit (Tite-Joint Left Edge).....			WF-4
F4150	Starter Unit (Dowel Joined).....			WF-4